

CPDF3V3UP-HF

RoHS Device
Halogen Free



Features

- Working voltage: 3.3V
- Low leakage current.
- Low operating and clamping voltages.

Mechanical data

- Case: 1005/SOD-323F standard package, molded plastic.
- Terminals: Gold plated, solderable per MIL-STD-750, method 2026.
- Marking code: E3V3
- Mounting position: Any
- Weight: 0.003 gram(approx.).

Circuit Diagram

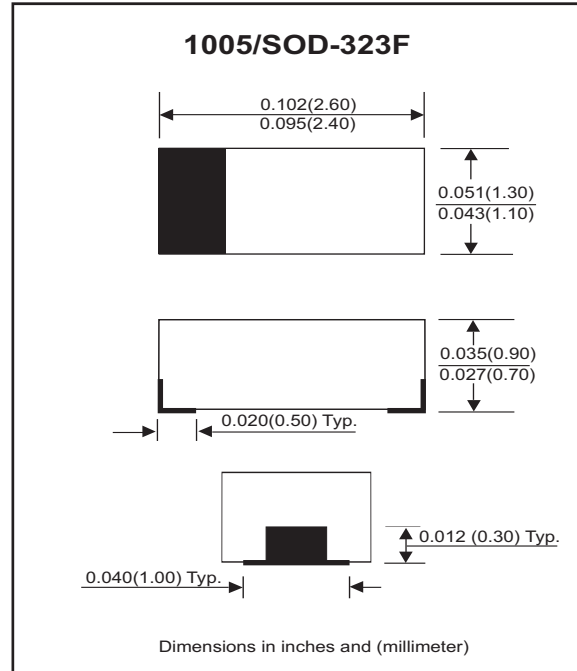

Maximum Rating (at TA=25°C unless otherwise noted)

Parameter	Symbol	Value	Unit
Peak pulse power (tp = 8/20 us)	PPP	40	W
Peak pulse current (tp = 8/20 us)	I _{PP}	5	A
ESD per IEC 61000-4-2(Air) ESD per IEC 61000-4-2(Contact)	V _{ESD}	±20 ±15	kV
Operating temperature	T _j	-55 to +125	°C
Storage temperature	T _{STG}	-55 to +125	°C

Electrical Characteristics (at TA=25 °C unless otherwise noted)

Parameter	Conditions	Symbol	Min	Typ	Max	Unit
Reverse stand-off voltage		V _{RWM}			3.3	V
Punch-through voltage	I _{PT} = 2uA	V _{PT}	3.5			V
Snap-back voltage	I _{SB} = 50mA	V _{SB}	2.8			V
Reverse leakage current	V _{RWM} = 3.3V	I _R		0.05	0.5	uA
Clamping voltage	I _{PP} = 1 A, tp=8/20us	V _C			5.5	V
	I _{PP} = 5 A, tp=8/20us	V _C			8.0	V
Reverse clamping voltage	I _{PPR} = 1 A, tp=8/20us	V _{CR}			2.4	V
Junction capacitance	V _R = 0 V, f = 1MHz	C _j		12	16	pF

RATING AND CHARACTERISTIC CURVES (CPDF3V3UP-HF)

Fig. 1 - Non-repetitive max. peak pulse power vs. pulse time

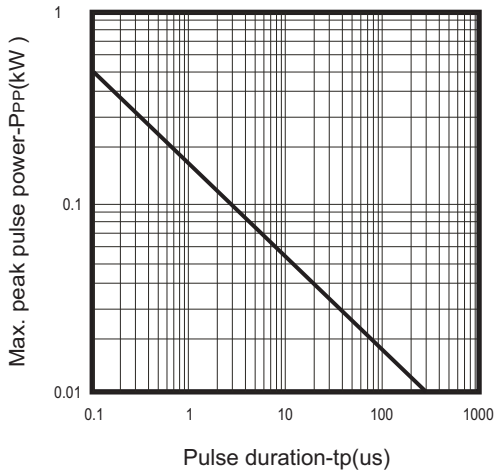

Fig. 2 - Power rating derating curve

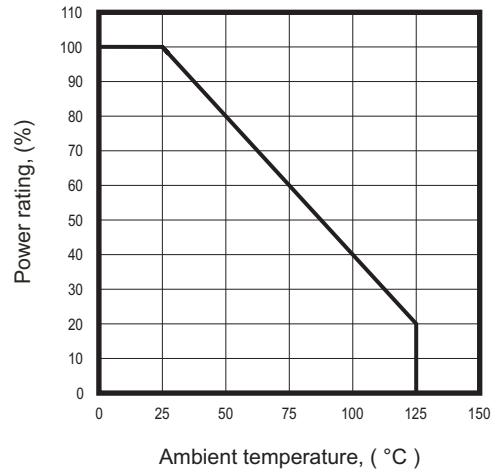

Fig.3 - Clamping voltage vs. peak pulse current

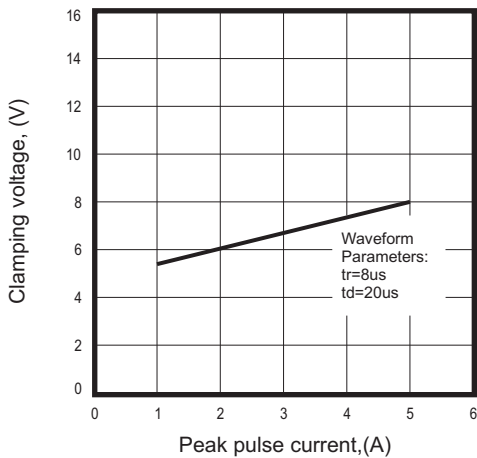

Fig.4 - Forward voltage vs. Forward current

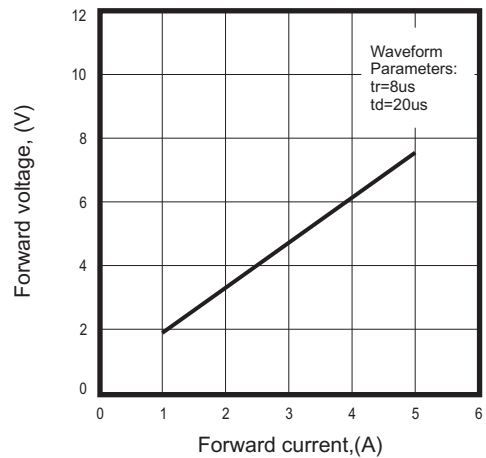
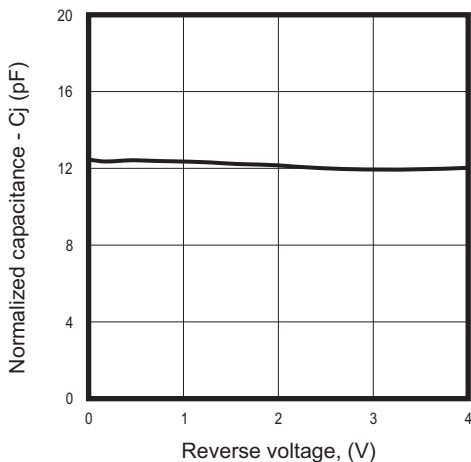
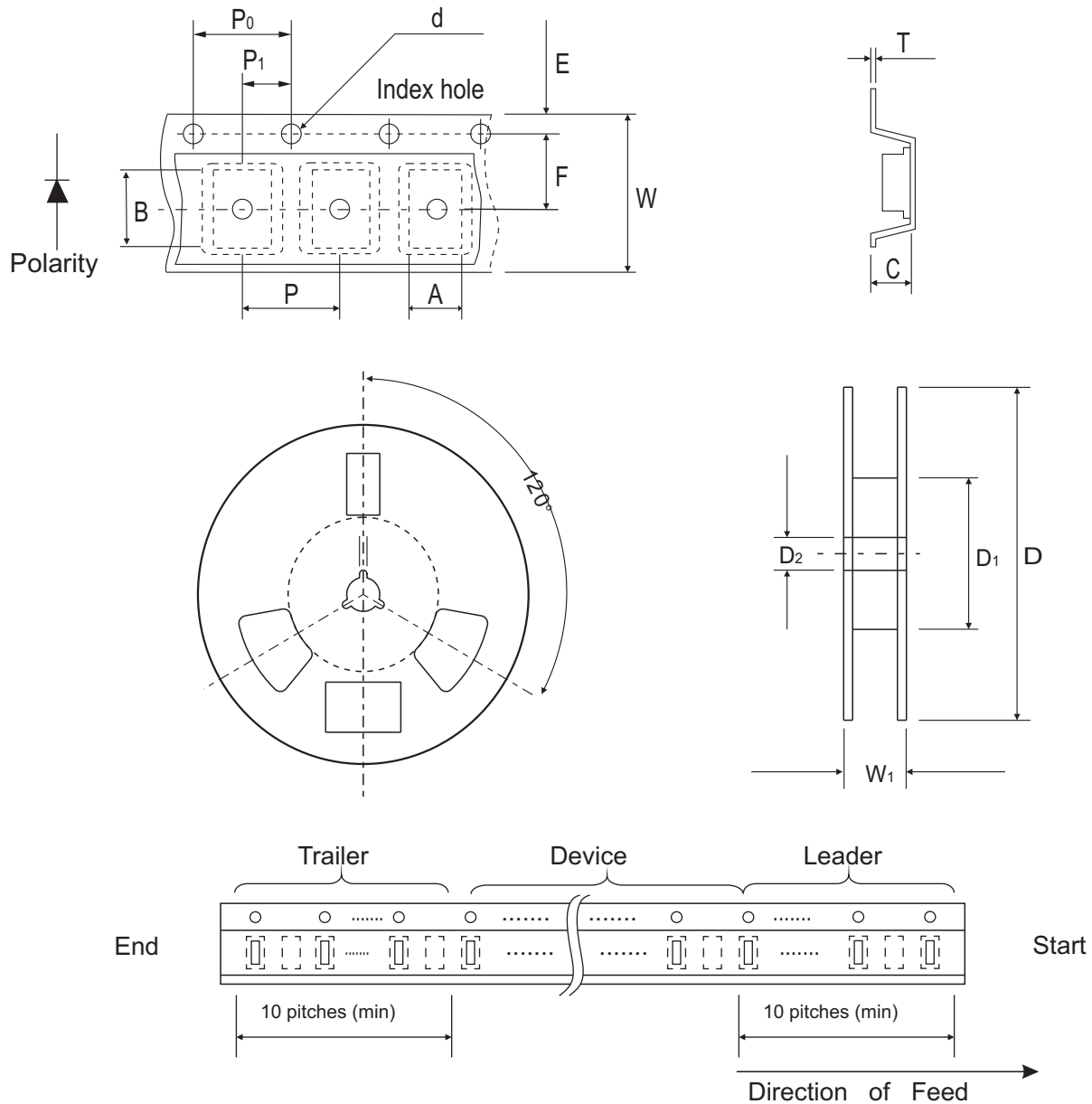

Fig.5 - Junction capacitance vs. reverse voltage



Reel Taping Specification



1005 (SOD-323F)	SYMBOL	A	B	C	d	D	D ₁	D ₂
	(mm)	1.55 ± 0.10	2.65 ± 0.10	1.05 ± 0.10	1.55 ± 0.05	178 ± 1	60.0 MIN.	13.0 ± 0.20
	(inch)	0.061 ± 0.004	0.104 ± 0.004	0.041 ± 0.004	0.061 ± 0.002	7.008 ± 0.04	2.362 MIN.	0.512 ± 0.008

1005 (SOD-323F)	SYMBOL	E	F	P	P ₀	P ₁	T	W	W ₁
	(mm)	1.75 ± 0.10	3.50 ± 0.05	4.00 ± 0.10	4.00 ± 0.10	2.00 ± 0.05	0.23 ± 0.05	8.00 ± 0.20	13.5 MAX.
	(inch)	0.069 ± 0.004	0.138 ± 0.002	0.157 ± 0.004	0.157 ± 0.004	0.079 ± 0.004	0.009 ± 0.002	0.315 ± 0.008	0.531 MAX.

Marking Code

Part Number	Marking Code
CPDF3V3UP-HF	E3V3



Suggested PAD Layout

SIZE	1005/SOD-323F	
	(mm)	(inch)
A	2.10	0.083
B	1.20	0.047
C	1.20	0.047
D	3.30	0.130
E	0.90	0.035

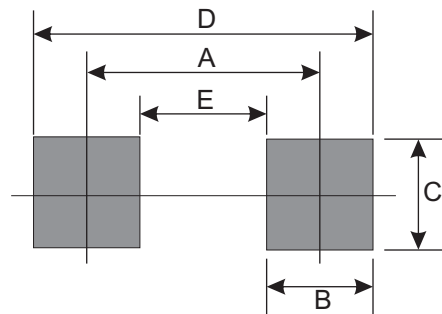

Standard Packaging

Case Type	Qty Per Reel	Reel Size
	(Pcs)	(inch)
1005/SOD-323F	4,000	7